



	<b>LBA127</b>	<b>Units</b>
Load Voltage	250	V
Load Current	200	mA
Max R <sub>ON</sub>	10	Ω

### Description

LBA127 is 250V, 200mA, 10Ω independent 1-Form-A and 1-Form-B relays. It features a superior combination of low on-resistance and enhanced peak load current handling capabilities. Current limiting version is available ("L" suffix, see specification for variations in performance).

### Features

- Small 8 Pin DIP Package
- Low Drive Power Requirements (TTL/CMOS Compatible)
- No Moving Parts
- High Reliability
- Arc-Free With No Snubbing Circuits
- 3750V<sub>RMS</sub> Input/Output Isolation
- FCC Compatible
- VDE Compatible
- No EMI/RFI Generation
- Machine Insertable, Wave Solderable
- Surface Mount and Tape & Reel Version Available

### Applications

- Telecommunications
  - Telecom Switching
  - Tip/Ring Circuits
  - Modem Switching (Laptop, Notebook, Pocket Size)
  - Hookswitch
  - Dial Pulsing
  - Ground Start
  - Ringer Injection
- Instrumentation
  - Multiplexers
  - Data Acquisition
  - Electronic Switching
  - I/O Subsystems
  - Meters (Watt-Hour, Water, Gas)
- Medical Equipment-Patient/Equipment Isolation
- Security
- Aerospace
- Industrial Controls

### Approvals

- UL Recognized: File Number E76270
- CSA Certified: File Number LR 43639-10
- BSI Certified to:
  - BS EN 60950:1992 (BS7002:1992)  
Certificate #: 7344
  - BS EN 41003:1993  
Certificate #: 7344

### Ordering Information

<b>Part #</b>	<b>Description</b>
LBA127	8 Pin DIP (50/Tube)
LBA127P	8 Pin Flatpack (50/Tube)
LBA127PTR	8 Pin Flatpack (1000/Reel)
LBA127S	8 Pin Surface Mount (50/Tube)
LBA127STR	8 Pin Surface Mount (1000/Reel)

### Pin Configuration

#### LBA127 Pinout

AC/DC Configuration

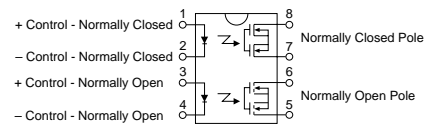

Switching Characteristics of Normally Open (Form A) Devices

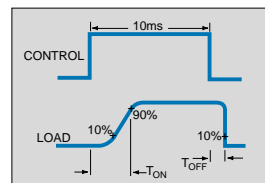

Switching Characteristics of Normally Closed (Form B) Devices

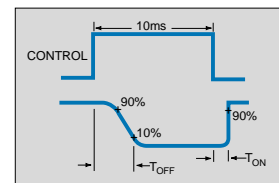

### Absolute Maximum Ratings (@ 25° C)

Parameter	Min	Typ	Max	Units
Input Power Dissipation	-	-	150 <sup>1</sup>	mW
Input Control Current	-	-	50	mA
Peak (10ms)	-	-	1	A
Reverse Input Voltage	-	-	5	V
Total Power Dissipation	-	-	800 <sup>2</sup>	mW
Isolation Voltage Input to Output	3750	-	-	V <sub>RMS</sub>
Operational Temperature	-40	-	+85	°C
Storage Temperature	-40	-	+125	°C
Soldering Temperature DIP Package	-	-	+260	°C
Flatpack/Surface Mount Package (10 Seconds Max.)	-	-	+220	°C

<sup>1</sup> Derate Linearly 1.33 mW/°C

<sup>2</sup> Derate Linearly 6.67 mW/°C

*Absolute Maximum Ratings are stress ratings. Stresses in excess of these ratings can cause permanent damage to the device. Functional operation of the device at these or any other conditions beyond those indicated in the operational sections of this data sheet is not implied. Exposure of the device to the absolute maximum ratings for an extended period may degrade the device and effect its reliability.*

### Electrical Characteristics

Parameter	Conditions	Symbol	Min	Typ	Max	Units
<b>Output Characteristics @ 25°C</b>						
Load Voltage (Peak)	-	V <sub>L</sub>	-	-	250	V
Load Current (Continuous) AC/DC Configuration	-	I <sub>L</sub>	-	-	200	mA
Peak Load Current	10ms	I <sub>LPK</sub>	-	-	400	mA
On-Resistance AC/DC Configuration	I <sub>L</sub> =Load Current	R <sub>ON</sub>	-	8	10	Ω
Off-State Leakage Current	V <sub>L</sub> =250V	I <sub>LEAK</sub>	-	-	1	μA
Switching Speeds						
Turn-On	I <sub>F</sub> =5mA, V <sub>L</sub> =10V	T <sub>ON</sub>	-	-	5	ms
Turn-Off	I <sub>F</sub> =5mA, V <sub>L</sub> =10V	T <sub>OFF</sub>	-	-	5	ms
Output Capacitance	50V; f=1MHz	C <sub>OUT</sub>	-	110	-	pF
<b>Input Characteristics @ 25°C</b>						
Input Control Current	I <sub>L</sub> =Load Current	I <sub>F</sub>	5	-	50	mA
Input Dropout Current	-	I <sub>F</sub>	0.4	0.7	-	mA
Input Voltage Drop	I <sub>F</sub> =5mA	V <sub>F</sub>	0.9	1.2	1.4	V
Reverse Input Voltage	-	V <sub>R</sub>	-	-	5	V
Reverse Input Current	V <sub>R</sub> =5V	I <sub>R</sub>	-	-	10	μA
Input to Output Capacitance	-	C <sub>I/O</sub>	-	3	-	pF
Input to Output Isolation	-	V <sub>I/O</sub>	3750	-	-	V <sub>RMS</sub>

\*NOTE: If both poles operate simultaneously load current must be derated so as not to exceed the package power dissipation value.

PERFORMANCE DATA\*

**LBA127**  
Typical LED Forward Voltage Drop  
(N=50 Ambient Temperature = 25°C; I<sub>F</sub> = 5mADC)

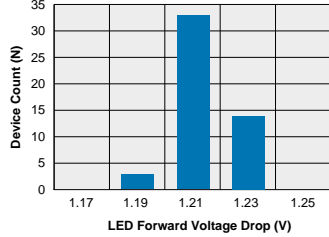

**LBA127 - FormA**  
Typical On-Resistance Distribution  
(N=50 Ambient Temperature = 25°C)  
(Load Current = 170mADC, I<sub>F</sub>=5mADC)

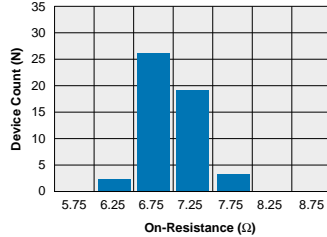

**LBA127 - FormB**  
Typical On-Resistance Distribution  
(N=50 Ambient Temperature = 25°C)  
(Load Current = 170mADC, I<sub>F</sub>=5mADC)

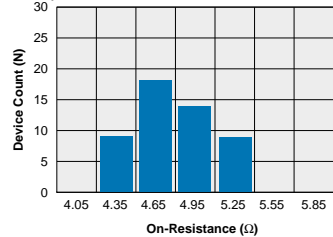

**LBA127 - FormA**  
Typical Blocking Voltage Distribution  
(N=50 Ambient Temperature = 25°C)

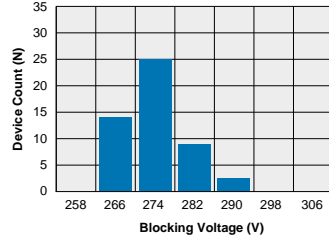

**LBA127 - FormB**  
Typical Blocking Voltage Distribution  
(N=50 Ambient Temperature = 25°C)

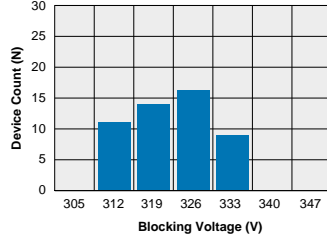

**LBA127 - FormA**  
Typical I<sub>F</sub> for Switch Operation  
(N=50 Ambient Temperature = 25°C)  
(Load Current = 170mADC)

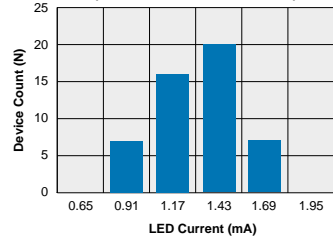

**LBA127 - FormB**  
Typical I<sub>F</sub> for Switch Operation  
(N=50 Ambient Temperature = 25°C)  
(Load Current = 170mADC)

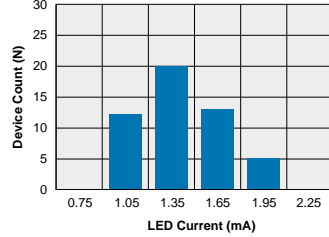

**LBA127 - FormA**  
Typical I<sub>F</sub> for Switch Dropout  
(N=50 Ambient Temperature = 25°C)  
(Load Current = 170mADC)

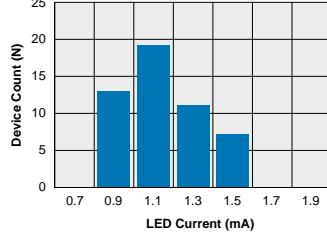

**LBA127 - FormB**  
Typical I<sub>F</sub> for Switch Dropout  
(N=50 Ambient Temperature = 25°C)  
(Load Current = 170mADC)

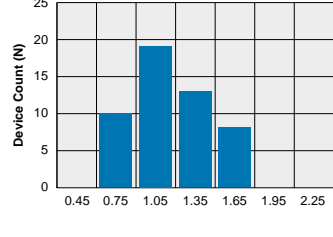

**LBA127 - FormA**  
Typical Turn-On Time  
(N=50 Ambient Temperature = 25°C)  
(Load Current = 170mADC; I<sub>F</sub> = 5mADC)

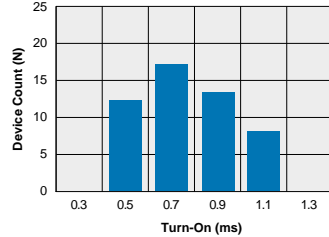

**LBA127 - FormB**  
Typical Turn-On Time  
(N=50 Ambient Temperature = 25°C)  
(Load Current = 170mADC; I<sub>F</sub> = 5mADC)

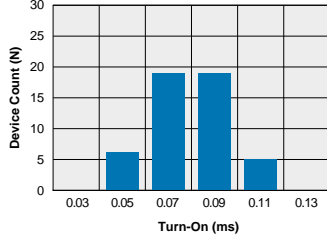

**LBA127 - FormA**  
Typical Turn-Off Time  
(N=50 Ambient Temperature = 25°C)  
(Load Current = 170mADC; I<sub>F</sub> = 5mADC)

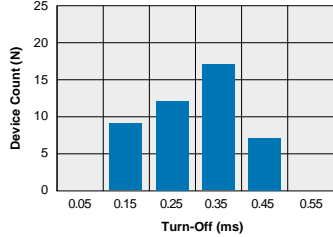

The Performance data shown in the graphs above is typical of device performance. For guaranteed parameters not indicated in the written specifications, please contact our application department.

PERFORMANCE DATA\*

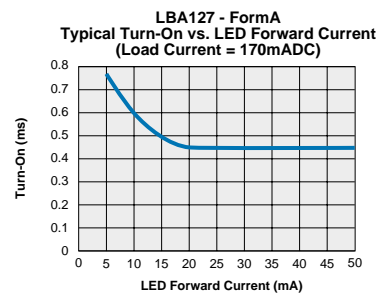
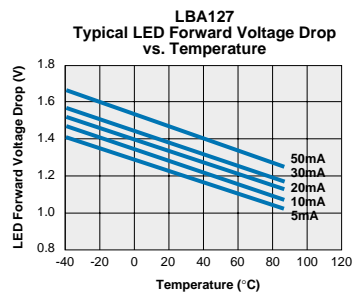
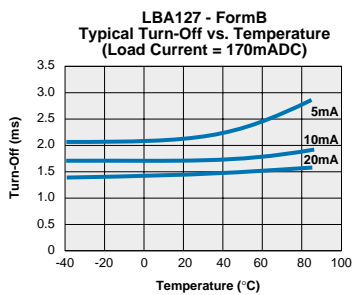
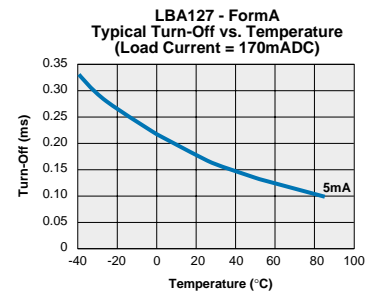
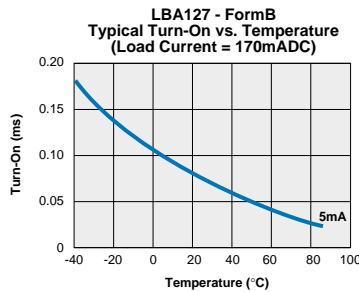
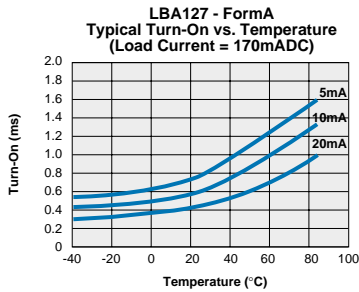
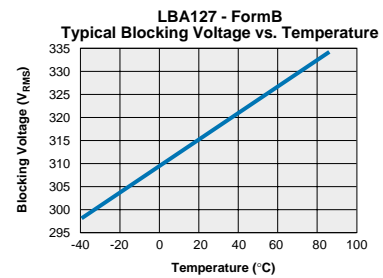
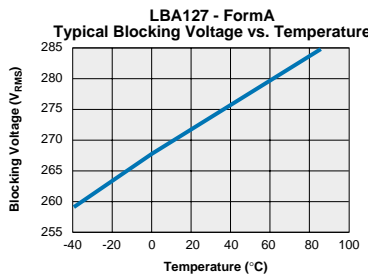
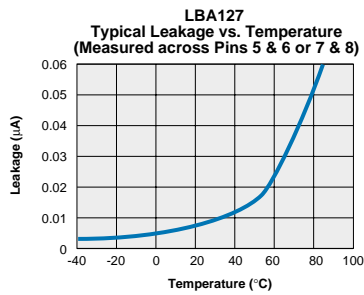
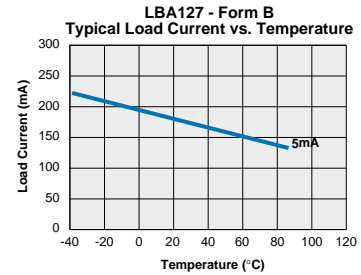
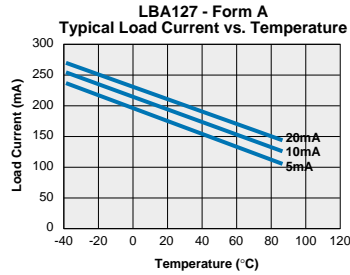
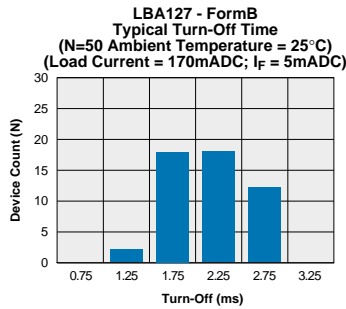

\*The Performance data shown in the graphs above is typical of device performance. For guaranteed parameters not indicated in the written specifications, please contact our application department.

PERFORMANCE DATA\*

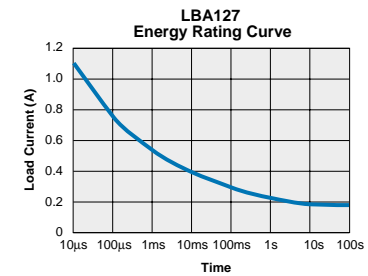
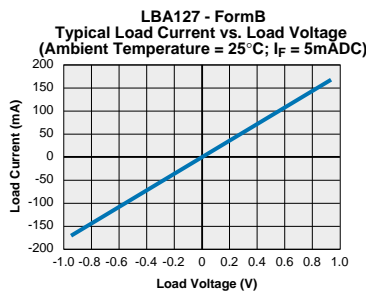
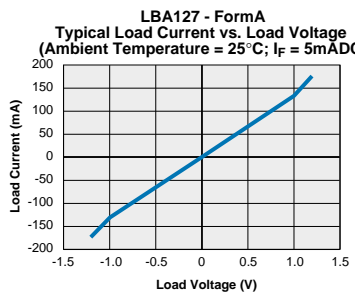
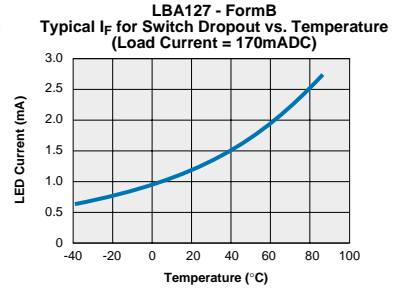
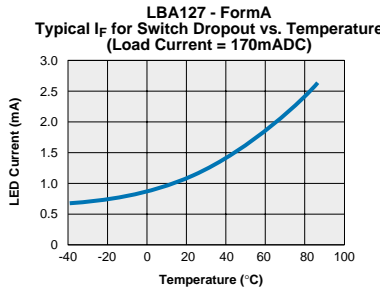
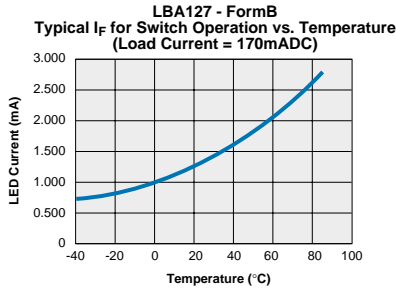
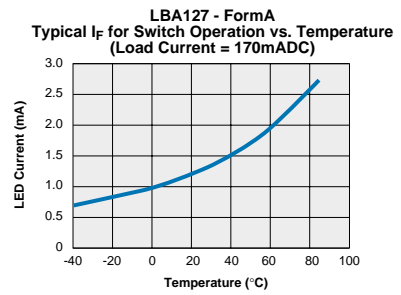
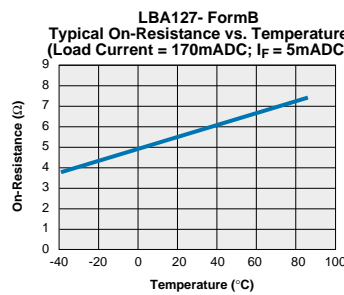
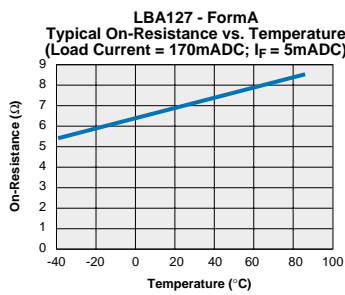
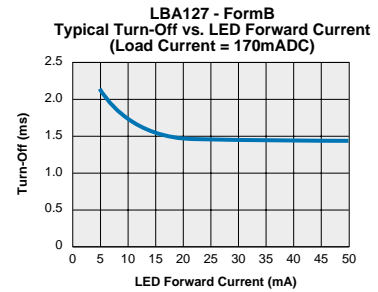
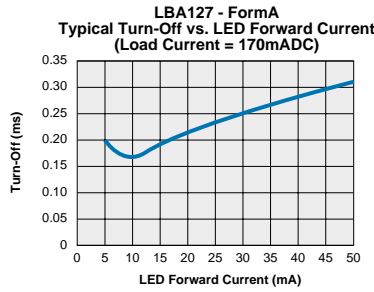
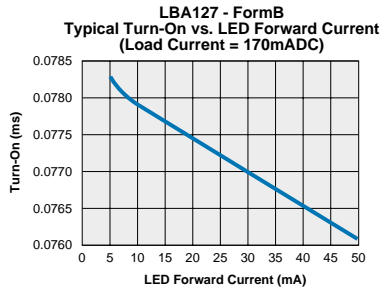

\*The Performance data shown in the graphs above is typical of device performance. For guaranteed parameters not indicated in the written specifications, please contact our application department.

**Mechanical Dimensions**

**8 Pin DIP Through Hole (Standard)**

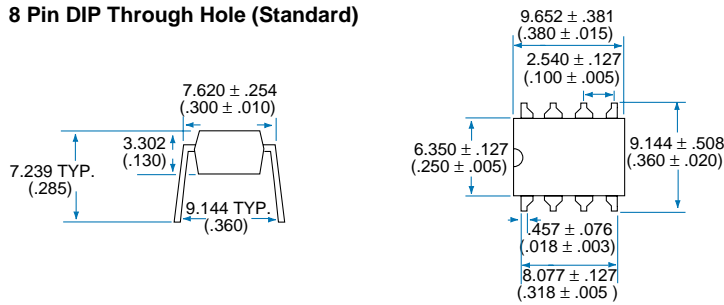

**PC Board Pattern (Top View)**

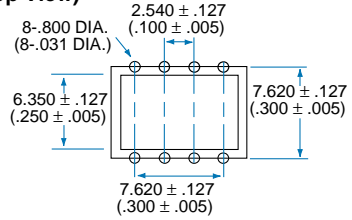

**8 Pin DIP Surface Mount ("S" Suffix)**

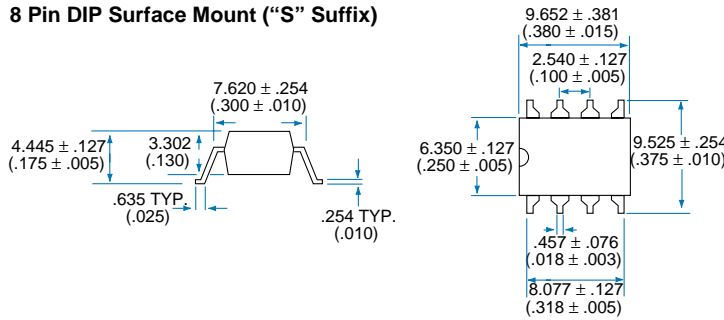

**PC Board Pattern (Top View)**

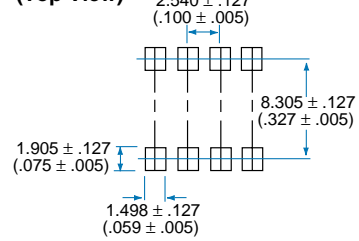

**8 Pin Flatpack ("P" Suffix)**

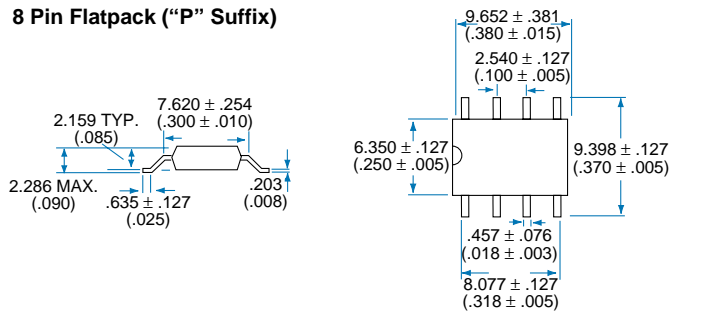

**PC Board Pattern (Top View)**

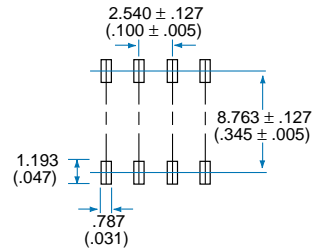

Dimensions  
 mm  
 (inches)

### Mechanical Dimensions

#### Tape and Reel Packaging for 8 Pin Flatpack Package

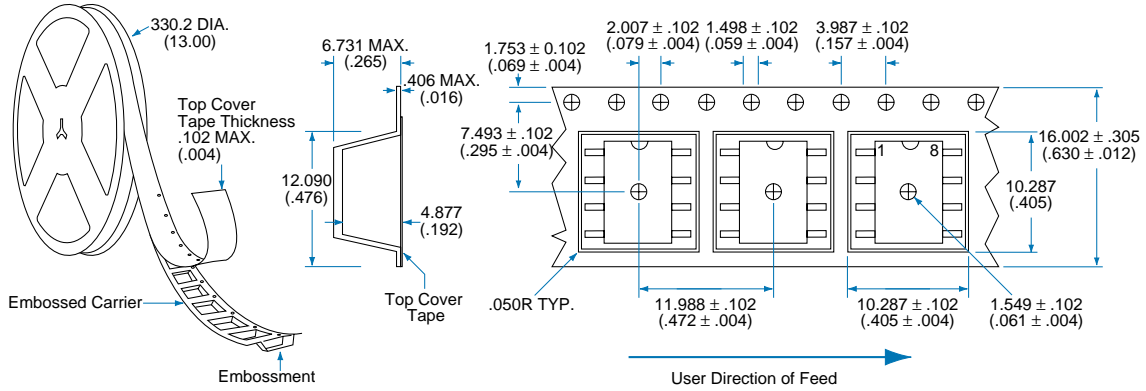

#### Tape and Reel Packaging for 8 Pin Surface Mount Package

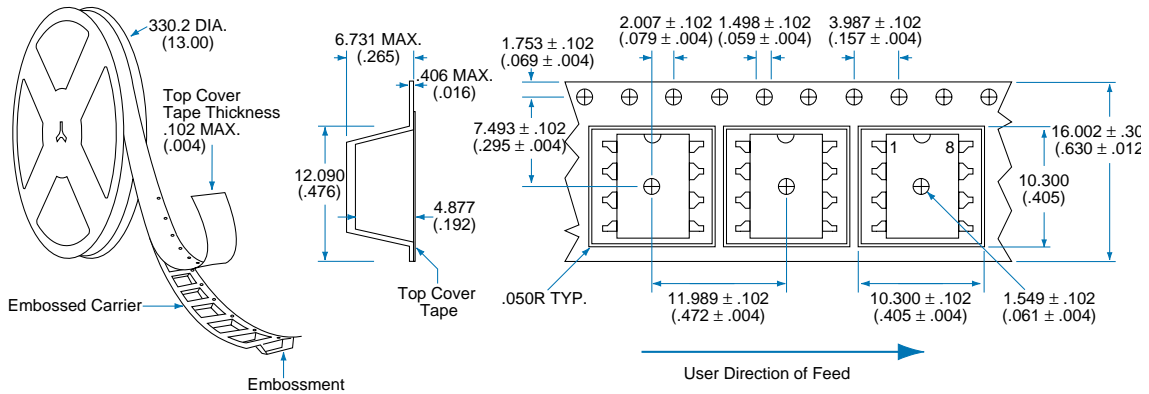

Dimensions  
mm  
(inches)



# CLARE

---

**For additional information please visit our website at: [www.clare.com](http://www.clare.com)**

*Clare, Inc. makes no representations or warranties with respect to the accuracy or completeness of the contents of this publication and reserves the right to make changes to specifications and product descriptions at any time without notice. Neither circuit patent licenses nor indemnity are expressed or implied. Except as set forth in Clare's Standard Terms and Conditions of Sale, Clare, Inc. assumes no liability whatsoever, and disclaims any express or implied warranty, relating to its products including, but not limited to, the implied warranty of merchantability, fitness for a particular purpose, or infringement of any intellectual property right.*

*The products described in this document are not designed, intended, authorized or warranted for use as components in systems intended for surgical implant into the body, or in other applications intended to support or sustain life, or where malfunction of Clare's product may result in direct physical harm, injury, or death to a person or severe property or environmental damage. Clare, Inc. reserves the right to discontinue or make changes to its products at any time without notice.*

Specification: DS-LBA127-R8.0  
©Copyright 2002, Clare, Inc.  
All rights reserved. Printed in USA.  
6/25/02